

MODEL 7ASX-8 *HD* ^{EAVY} _{DUTY} - SPECIFICATION

1.0 General Specifications

There shall be furnished one (1) one only Grind Hog™ Model 7ASX-8 HEAVY DUTY Comminutor as manufactured by **G.E.T. Industries Inc.** with rotation in a counter-clockwise direction.

1.1 Design Criteria

The comminutor shall be designed to handle the flows indicated below, within the head loss noted.

- a) hydraulic capacity 315 GPM (19.9 l/s)
- b) satisfactory operation shall occur under conditions of zero flow
- c) head loss at peak flow shall not exceed 10 inches (250)
- d) design shall be such that the flow enters the size reduction and screening device horizontally and exists vertically downward to facilitate the flushing of solids

1.2 Rotating Drum Screen

- a) heavy-duty Cast Ductile Iron ASTM 536, grade 60-45-18

1.3 Cutting Elements

- a) replaceable shear bars constructed of high-quality A2 tool-steel shall be attached to the rotating drum. Each shear bar shall be machined from solid bar stock, surface ground to establish exact tolerances
- b) stationary cutting bar shall be of high-quality 01 tool steel hardened to a minimum of 56 Rockwell C, and shall be reversible, allowing for four (4) sets of cutting edges prior to sharpening or replacement
- c) all submerged fasteners shall be of stainless steel

1.4 Flanged Body

- a) the body of the comminutor shall be of high quality cast iron and so designed to allow free unobstructed flow of influent through the unit. A Neoprene "O" Ring shall seal the chamber, allowing for operation under conditions of abnormally high head
- b) the inlet flange shall be 8" (200)

1.5 Motor

Submersible, Explosion-proof 1 Hp. (.746 kw), 1750 RPM _____ volt, 3 phase, 60 HZ, rated for continuous-in-air or submerged in sewage service. Power control cable of 25 ft (7.6 m) included. Class 1, Group C and D, Division 1 Hazardous locations. The motor shall feature:

- **Frame** - rugged cast iron ASTM type A-48, class 30
- **Hardware** - 316 stainless steel
- **Stator Insulation** - specially treated class "F" and "H" non-hygroscopic insulation with multiple dips and brakes. Phase insulation included for inverter duty
- **Rotor** - die cast aluminum, dynamically balanced. Exceeds NEMA limits per MGI - 12.06
- **Shaft** - high strength 416 stainless steel
- **Bearings** - specially adapted for vertical assembly. Both upper and lower bearings are pre-packed and sealed for life with special high temperature grease
- **Cable Entry System** - epoxy sealed butt spliced connect for non-wicking cable entry design
- **Moisture System** - two wire /two probe monitoring system constantly monitors oil chamber and stator housing for moisture
- **Seals** - tandem (dual) shaft seal system working independent of each other. Designed to withstand 100 PSI at all seal locations



MODEL 7ASX-8 ^{EA}HD _{VY} - SPECIFICATION cont'd...

1.6 Drive Arrangement

- a) the motor shall be close-coupled to a speed reducer drive, a heavy duty planetary gear of the totally enclosed non-vented type suitable for total submergence during emergencies
- b) double seals on the output shaft shall ensure flood-proof operation through a reduction ratio of 35:1
- c) the cycloidal reducer shall be capable of withstanding shock loads to 500% of its mechanical rating of 4.27 Hp. and be warranted for two (2) years
- d) the drive shall have a minimum full load efficiency of 90% and be pre-lubricated with grease, requiring routing maintenance every 500 to 1,000 hours

OPTIONAL INSTALLATION ARRANGEMENTS

A) Auto-Coupling Slide Rail System - Wet Well

- a) each Grind Hog™ shall be equipped with a Slide Rail System allowing for removal without entering the wet well
- b) a stationary PVC Overflow Coupling Box shall be flange mounted to the gravity sewer pipe as shown on the drawings. An open top will allow for overflow in the event of a disruption in service
- c) Wall Mounted Support Brackets shall be 304 stainless steel and shall be attached to the wet well wall
- d) Guide Rails shall be of 304 stainless steel pipe, 1.5" in diameter, and shall be of adequate length as shown on the drawings
- e) all anchorage hardware shall be of stainless steel, supplied by the contractor

B) Auto-Coupling Slide Rail System - Chamber

- a) each Grind Hog™ shall be equipped with a Slide Rail System allowing for removal without entering the manhole
- b) a stationary PVC Overflow Coupling Box shall be flange mounted to the gravity sewer pipe as shown on the drawings. An open top will allow for overflow in the event of a disruption in service
.... alternatively....
a stationary galvanized steel Overflow Bar Screen and influent trough shall be mounted under the gravity sewer pipe as shown on the drawing. Stainless steel support brackets and hardware shall be provided
- c) supports brackets shall be of stainless steel and shall be mounted to the:
* Manhole Wall - PVC Overflow option
* Manhole Floor - Overflow Bar Screen Option
- d) Guide Rail Supports shall be 304 stainless steel pipe. 1.5" diameter, and of adequate length as shown on the drawing
- e) all anchorage hardware shall be of stainless steel, supplied by the contractor

C) Trash Basket - Optional

- a) a Trash Basket compatible with the Slide Rail System shall be provided, allowing for continued screening during comminutor maintenance. Materials of construction are:
* 10 Gauge Aluminum
* 2" (51) holes on 3" (76) centers

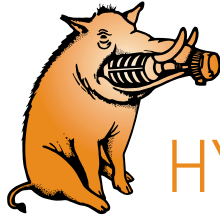

Grind Hog™

HYDRAULIC DATA SHEET PIPE MOUNTED MODEL 7

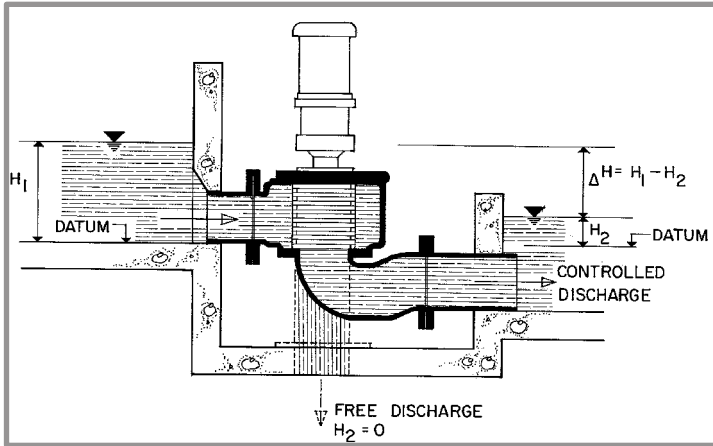

GENERAL DATA

Capacity	0-315 GPM (US)	0-19.9 L/s
Drum Diam.	6.8 in	17.3 cm
Inlet Area	34 in ²	219.4 cm ²
Outlet Area	20 in ²	129 cm ²
Slot Width	0.470 in	12 mm

- MODEL 7A** - FREE DISCHARGE
MODEL 7B - CONTROLLED DISCHARGE WITH
- CAST IRON RETURN BEND
 - PVC RETURN BEND

HYDRAULIC PERFORMANCE CURVE

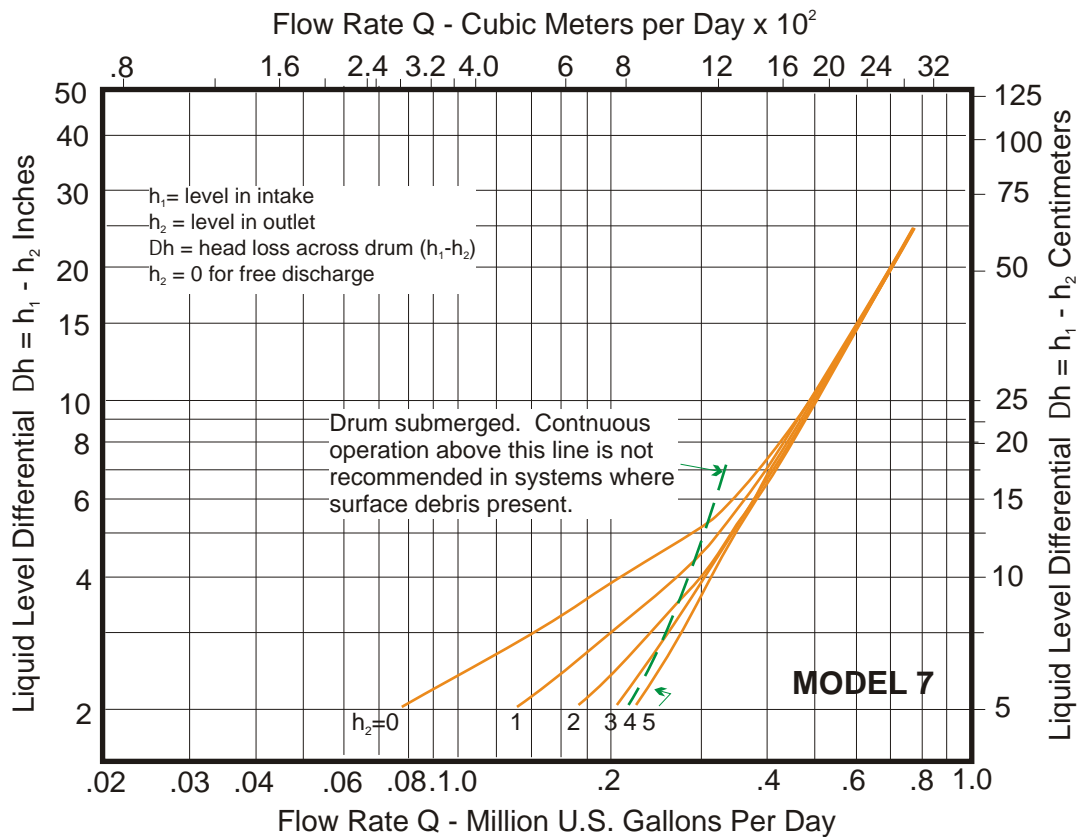

G.E.T. Industries Inc.

Toll Free: (877) 213-7418

E-mail: get@grindhog.com ♦ Web: www.grindhog.com



PIPE MOUNTED MODEL 7 cont'd...

DESIGN FEATURES

SM-CYCLO® SPEED REDUCERS

- HIGHEST OVERLOAD CAPACITY FOR FREQUENT STOP-START AND SEVERE REVERSING
- RELIABLE, MAINTENANCE-FREE SERVICE
- SMOOTH, SILENT OPERATION
- EXCEPTIONAL LIFE

Torque transmitting parts roll, don't grind. There is no sliding friction, so output torque/input horsepower efficiency approaches 95%.

SUBMERGED FASTENERS OF STAINLESS STEEL

HEAVY DUTY CAST IRON CONSTRUCTION

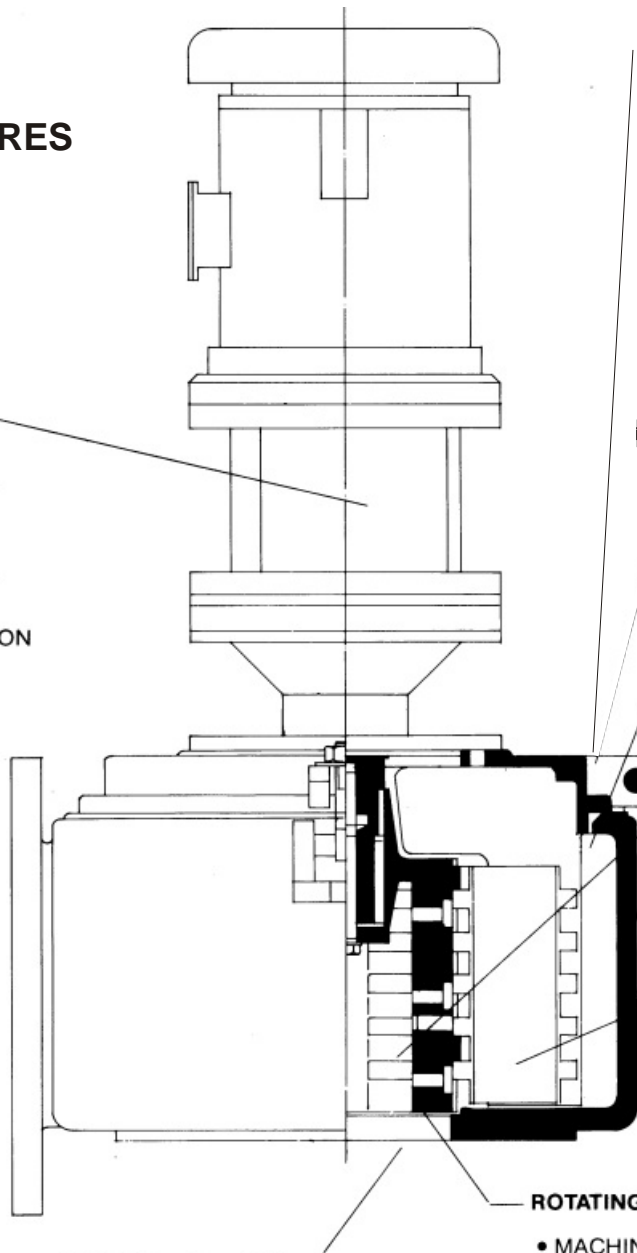

HINGED MECHANISM

- EASE OF INSPECTION
- RELEASE EYE-BOLTS SECURING COVER AND SWING CUTTING MECHANISM CLEAR OF CASING FOR INSPECTION AND MAINTENANCE

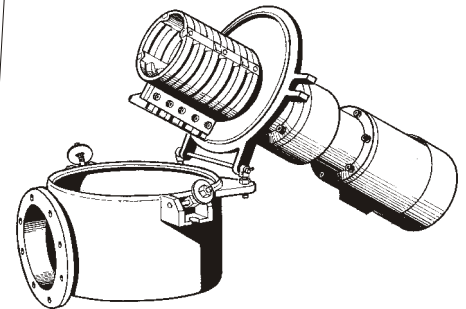

SEALED CHAMBER

- NEOPRENE "O" RING SEAL ALLOWS FOR SURCHARGED OPERATION

CAST DUCTILE IRON SEWAGE SCREEN

- LONG LIFE UNDER ABRASIVE CONDITIONS

STATIONARY CUTTING BAR

- REVERSIBLE-SPARE STANDARD EQUIPMENT
- A2 HIGH QUALITY TOOL STEEL
- HIGH RESISTANCE TO WEAR

ROTATING SHEAR BAR ASSEMBLY

- MACHINED FROM SOLID BARSTOCK
- PRECISE TOLERANCES MAINTAINED.

DISCHARGE OPTIONS

- FREE DISCHARGE TO TANK OR WET WELL
- CONTROLLED DISCHARGE — CAST IRON OR PVC RETURN BEND

G.E.T. Industries Inc.

Toll Free: (877) 213-7418

E-mail: get@grindhog.com ♦ Web: www.grindhog.com

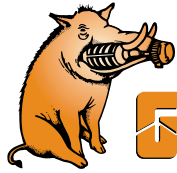

Grind Hog™ DIMENSIONAL & MECHANICAL DETAIL

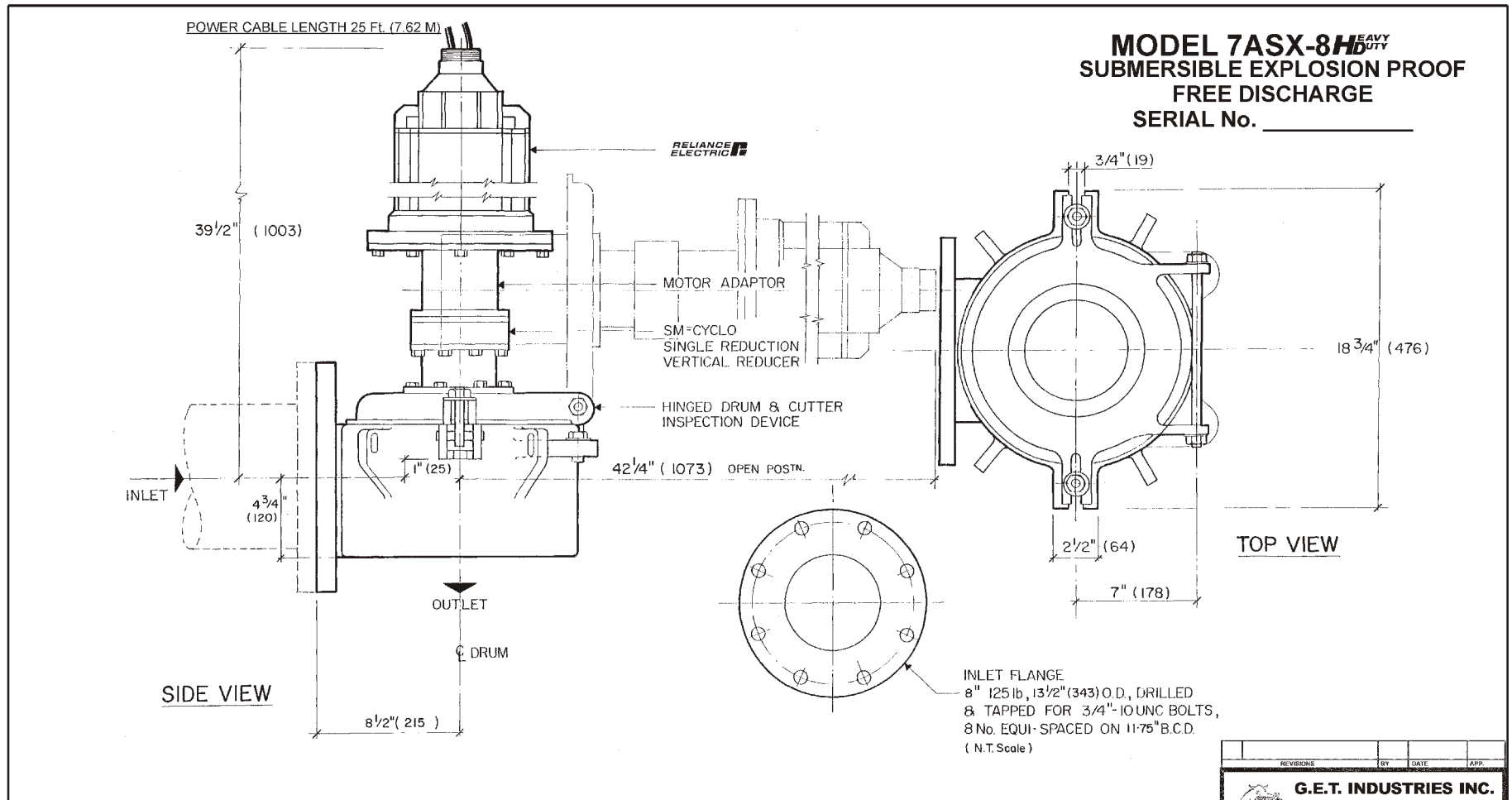

MODEL 7ASX-8HD^{HEAVY DUTY}
SUBMERSIBLE EXPLOSION PROOF
FREE DISCHARGE
 SERIAL No. _____

MATERIALS OF CONSTRUCTION & GENERAL ENGINEERING DATA					
HOUSING:	GREY IRON	CAPACITY:	315 GPM (US) / 19.9 L/s	INLET AREA:	34 sq in 219.4 cm sq
DRUM (SCREEN):	DUCTILE IRON (ASTM 536 GRADE 60-45-18)	DRUM SPEED:	50 RPM	OUTLET AREA:	20 sq in 129 cm sq
SHEAR BARS:	AISI-A2 HIGH ALLOY TOOL STEEL	ROTATION:	C / CLOCKWISE	DRUM DIAMETER:	6.5 in 16.5 cm
CUTTING BARS:	AISI-01 TOOL STEEL REVERSIBLE	SLOT WIDTH:	0.470 in / 12 mm	WEIGHT:	365 lb 166 kg
HARDWARE & FASTENERS:	304 STAINLESS STEEL	NO OF SLOTS:	20		
MOTOR MANUFACTURER:	Reliance	POWER:	/ /	RPM:	1750
SM-CYCLO REDUCER MODEL:	V6120	FRAME:	180TY	RATIO:	35:1
STYLE: SUB XP C-1A	HP: 1.0	KW: 746	FLANGE:	140TY	RATING: 4.27 HP

REVISIONS	BY	DATE	APP.
G.E.T. INDUSTRIES INC.			
(877) 213-7418			
www.grindhog.com			
TOLERANCES			SCALE
DECIMAL			NTS
FRACTIONAL			Techart
ANGULAR			APPROVED BY
			WDM
DATE	PROJECT NO.	DRAWING NO.	REV.
Oct. 2006		DD.7ASX-8 HD	